



Wall Mounted FDK

Model No.

- FDK15KXZE1
- FDK22KXZE1
- FDK28KXZE1
- FDK36KXZE1
- FDK45KXZE1
- FDK56KXZE1
- FDK71KXZE1
- FDK90KXZE1



Remote control (option)

Wired



Wireless



Elegant Timeless Design

The new FDK series air-conditioners have been stylishly designed with rounded contours that fit beautifully into any of Europe's diverse interior settings. The design was created by the Italian industrial design studio Tenso srl, based in Milan, to respond to a broad spectrum of local user needs. (15-56KXZE1)



Jet Technology

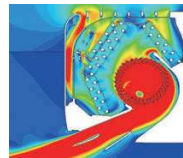

Fast Slow
Colors in the figure show the air speed.

FDK models adopt the air flow design that's proven to minimise resistance in a CFD analysis to achieve uniform air conditioning to the furthest corners of the room.

Flap control system

Selection of flap position is possible. A flap can be set at different angles.

*The wireless remote control is not applicable to the flap control system.

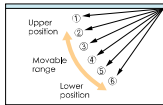

Lateral Swing Flap swings from right to left automatically

Up/Down Flap swing + Lateral swing

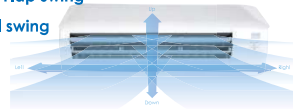

Specifications

Item	Model	FDK15KXZE1	FDK22KXZE1	FDK28KXZE1	FDK36KXZE1	FDK45KXZE1	FDK56KXZE1	FDK71KXZE1	FDK90KXZE1	
Nominal cooling capacity	kW	1.5	2.2	2.8	3.6	4.5	5.6	7.1	9.0	
Nominal heating capacity	kW	1.7	2.5	3.2	4.0	5.0	6.3	8.0	10.0	
Power source		1 Phase 220-240V, 50Hz								
Power consumption	Cooling	0.02-0.02			0.03-0.03			0.04-0.04	0.05-0.05	
	Heating	0.02-0.02			0.03-0.03			0.04-0.04	0.05-0.05	
Sound power level	dB(A)	54	55	58			Cooling: 58 Heating: 61	59	61	
Sound pressure level	Cooling	P-Hi:38 Hi:34 Me:31 Lo:28	P-Hi:38 Hi:36 Me:32 Lo:28	P-Hi:40 Hi:38 Me:33 Lo:28			P-Hi:43 Hi:41 Me:36 Lo:33	P-Hi:43 Hi:40 Me:37 Lo:33	P-Hi:44 Hi:42 Me:39 Lo:35	
	Heating	P-Hi:38 Hi:34 Me:31 Lo:28	P-Hi:38 Hi:36 Me:32 Lo:28	P-Hi:40 Hi:38 Me:33 Lo:28			P-Hi:43 Hi:41 Me:36 Lo:33	P-Hi:42 Hi:40 Me:37 Lo:33	P-Hi:44 Hi:42 Me:39 Lo:35	
Exterior dimensions H x W x D	mm	290 x 870 x 230								
Net weight	kg	11.5	11			11.5			17	
Air flow	Cooling	P-Hi:5.7 Hi:5 Me:4.5 Lo:3.4	P-Hi:8.5 Hi:8 Me:6 Lo:5			P-Hi:11 Hi:10 Me:8 Lo:7			P-Hi:12 Hi:11 Me:9 Lo:8	P-Hi:13 Hi:12 Me:10 Lo:8
	Heating	P-Hi:5.7 Hi:5 Me:4.5 Lo:3.4	P-Hi:8.5 Hi:8 Me:6 Lo:5			P-Hi:11 Hi:10 Me:8 Lo:7			P-Hi:12 Hi:11 Me:9 Lo:8	P-Hi:13 Hi:12 Me:10 Lo:8
Outside air intake		Not possible								
Air filter, Q'ty		Polypropylene net x2 (Washable)								
Remote control(option)		wired:RC-EX3A, RC-E5, RCH-E3 wireless:RCN-K-E2, RCN-K71-E2								
Installation data Refrigerant piping size	mm(in)	Liquid line:ø6.35(1/4") Gas line:ø9.52(3/8")			Liquid line:ø6.35(1/4") Gas line:ø12.7(1/2")			Liquid line:ø9.52(3/8") Gas line:ø15.88(5/8")		

1. The data are measured under the following conditions (ISO-T1). Cooling: Indoor temp. of 27°CDB, 19°CWB, and outdoor temp. of 35°CDB. Heating: Indoor temp. of 20°CDB, and outdoor temp. of 7°CDB, 4°CWB. 2. Sound pressure level indicates the value in an anechoic chamber. During operation these values are somewhat higher due to ambient conditions.

Dimensions

All measurements in mm.

FDK15KXZE1, 22KXZE1, 28KXZE1, 36KXZE1, 45KXZE1, 56KXZE1

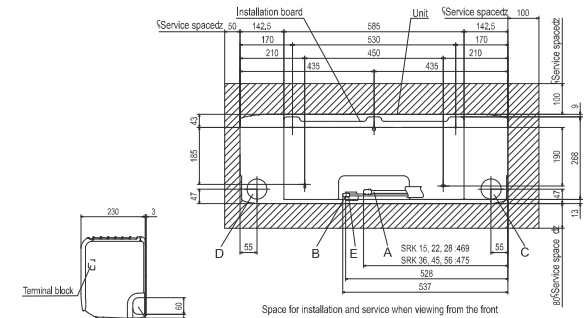
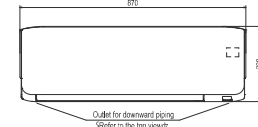

Symbol	Content
A	Gas piping SRK15, 22, 28 ø5.52(3/8") (ø6.35(1/4") if SRK22, 28, 36, 45, 56, 63, 71, 90)
B	Liquid piping SRK15, 22, 28 ø6.35(1/4") (ø6.35(1/4") if SRK22, 28, 36, 45, 56, 63, 71, 90)
C	Hole on wall for right rear piping ø66
D	Hole on wall for left rear piping ø66
E	Drain hose VP16
F	Outlet for expansion ball stock

FDK71KXZE1, 90KXZE1

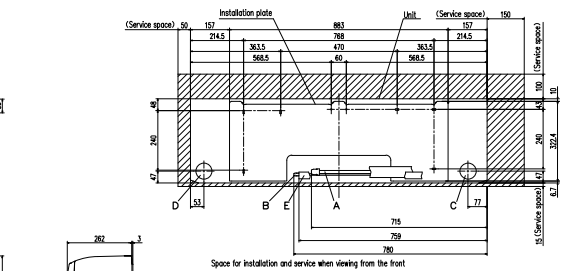
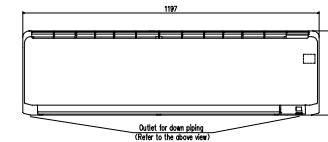

Symbol	Content
A	Gas piping ø15.88(5/8") (ø16)
B	Liquid piping ø16.35(1/2") (ø16)
C	Hole on wall for right rear piping ø66
D	Hole on wall for left rear piping ø66
E	Drain hose VP16
F	Outlet for wiring (on both sides) VP16
G	Outlet for piping (on both sides)